

URBE
▶▶▶▶
ADAPTA

Ref: UAM1361

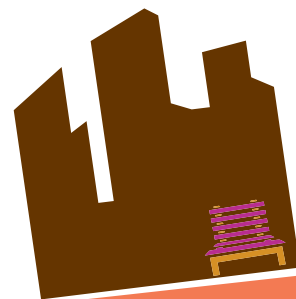

pilonas

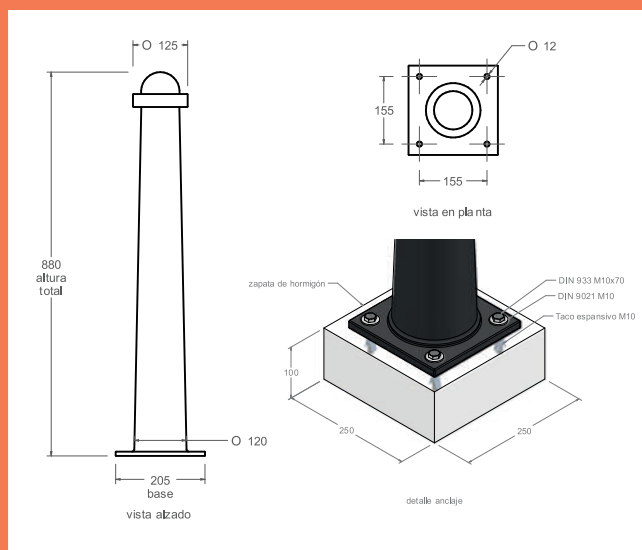

MATERIAL: Fundición gris tipo 20.

ACABADOS: Pintura oxiron negro.

MEDIDAS: 120 x 900 mm

PESO: 21,7 kg

ANCLAJES: 4 tornillos.



comercial@urbeadapta.com TELF: 661 534 251